

# OpenHouse® Cable/DSL Router

The H634 Cable/DSL Router with 4-port Switch connects multiple computers to a DSL or cable modem. "Plug and play" installation is easy when using the H628 data hub. The H634 is IEEE 802.3u 100 Base-TX Fast Ethernet compliant, IEEE 802.3 10 Base-T compliant and has activity LEDs for network status and diagnosis. The H634 can connect with up to four client computers directly. Up to 253 computers can be connected by using additional Ethernet switches (H638) or hubs.

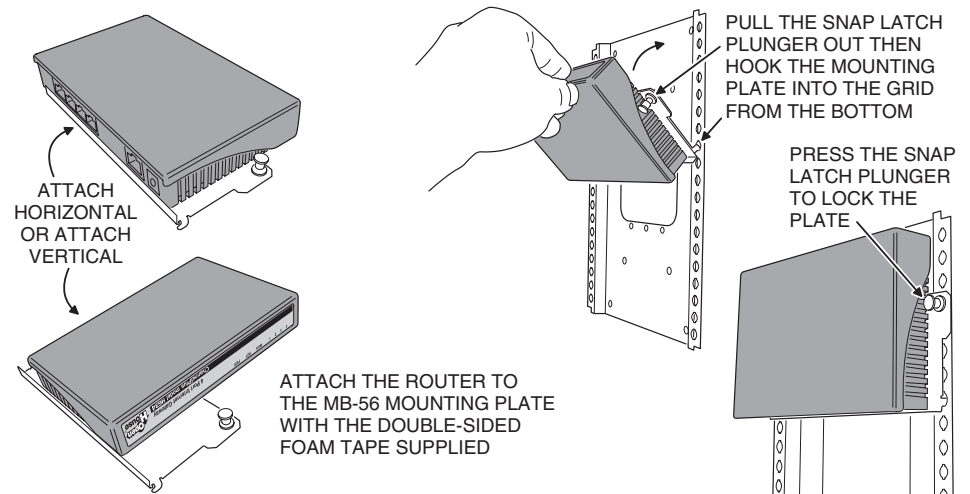

## Typical Telephone DSL Installation

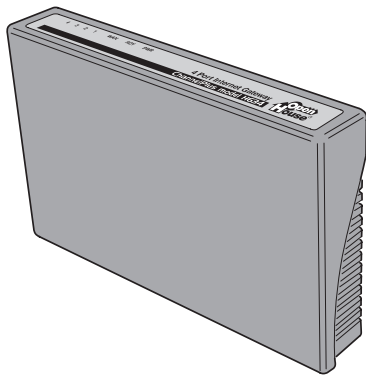
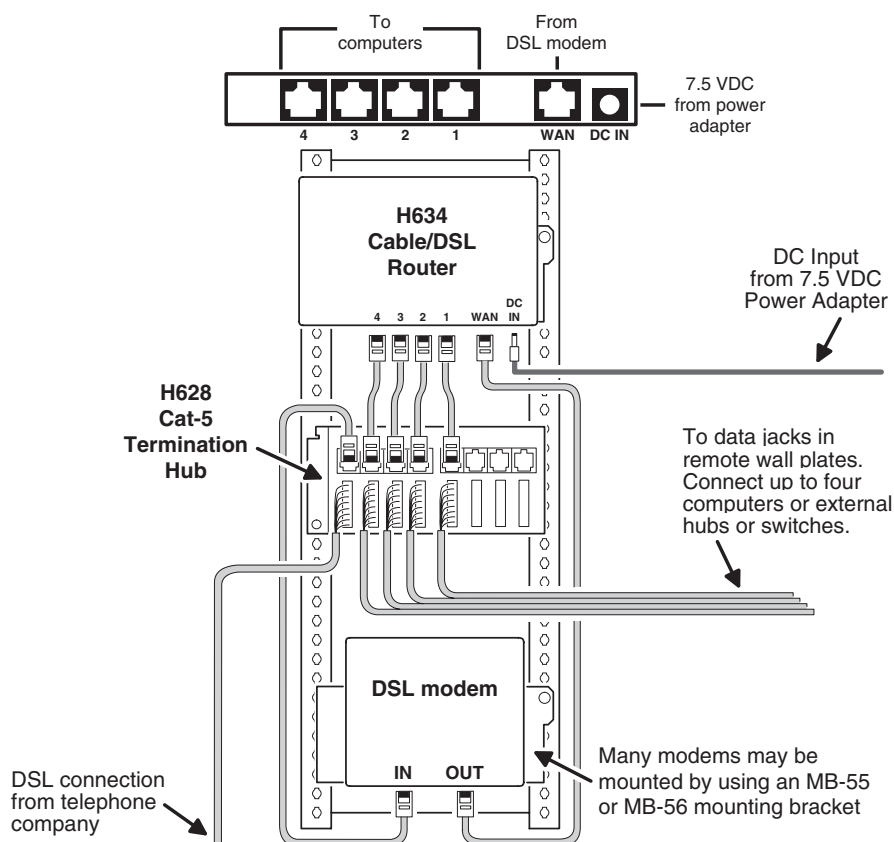

## Typical Broadband Cable Installation

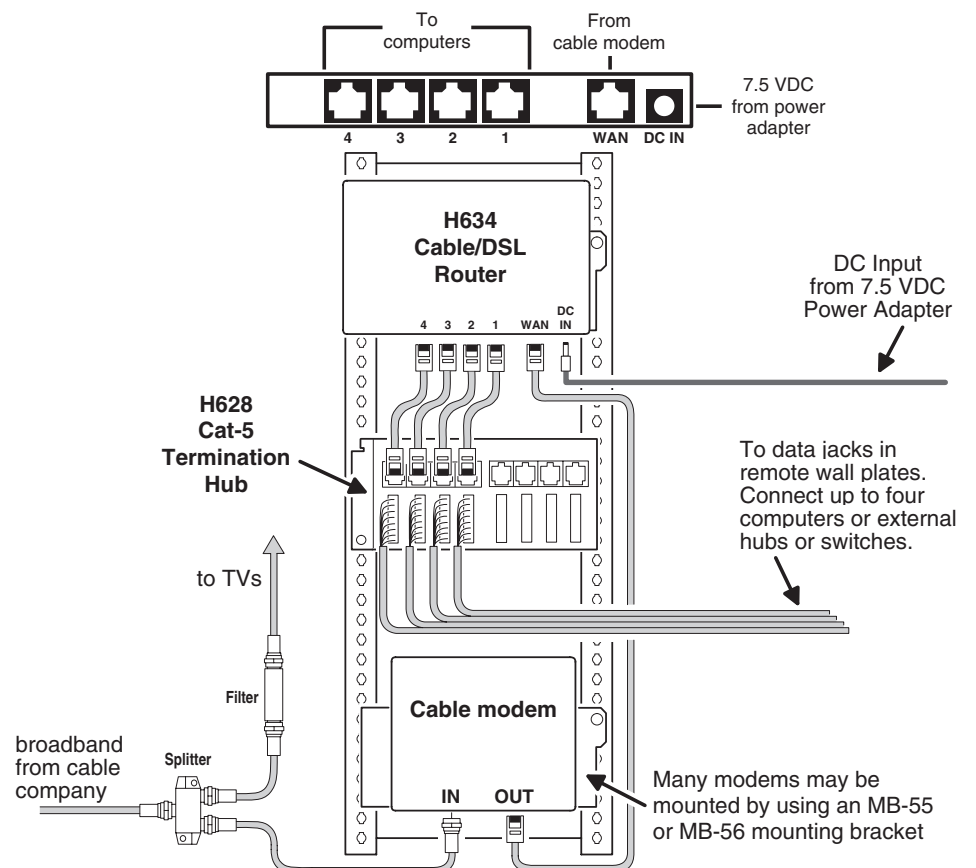

### Wiring the H634 Router

- Use only Category 5e unshielded twisted-pair cable for maximum performance.
- When connecting to an H628 or a network device directly, use straight through or crossover RJ-45 cables. All ports will automatically detect the cable type.
- Each run to a network device should be less than 100 meters (328 feet).

### LED Indicators

- **PWR** lights when power from transformer is present.
- **RDY** lights when router is ready for packet data from the WAN.
- **WAN** lights when wide area network packets are sent or received.
- **1-2-3-4** lights when packet data is being sent to, or received from, the client computers or additional hubs or switches.

### Specifications: Typical @ 25°C ± 5°C

<b>Compliance</b>	IEEE 802.3u IEEE 802.3	100 Base-TX, 10 Base-T and N-way auto-negotiation
<b>Network Interface</b>	RJ-45 ports	4 to client computers or hub/switch
	RJ-45 WAN	1 from DSL/cable modem
<b>Max Cable Length</b>	CAT-5e (UTP)	100 meters (328 feet)
<b>LED Indicators</b>	router & ports	PWR, RDY, WAN, Ports 1, 2, 3, & 4
<b>Environmental</b>	operating temperature	0°C to 40°C
	output current	1A maximum
<b>Power Supply</b>	output voltage	7.5 VDC
	input power	120 VAC

### Using Additional Hubs or Switches for Expansion

- Use only Category 5e unshielded twisted-pair cable for maximum performance.
- When connecting additional hubs or switches, use a straight through or crossover RJ-45 Category 5e cable. Category 5 patch cords may be used for short interconnections.
- The cable length between any two hubs or switches cannot exceed 100 meters (328 feet).
- All additional hubs or switches used must be self-powered.

### Declaration of Conformity

THIS DEVICE COMPLIES WITH PART 15 OF THE FCC RULES. OPERATION IS SUBJECT TO THE FOLLOWING TWO CONDITIONS: (1) THIS DEVICE MAY NOT CAUSE HARMFUL INTERFERENCE, AND (2) THIS DEVICE MUST ACCEPT ANY INTERFERENCE RECEIVED, INCLUDING INTERFERENCE THAT MAY CAUSE UNDESIRABLE OPERATION.

This equipment has been tested and found to comply with the limits for a Class B digital device, pursuant to Part 15 of the FCC Rules. These limits are designed to provide reasonable protection against harmful interference in a residential installation. This equipment generates, uses, and can radiate radio frequency energy and, if not installed and used according to the instructions, may cause harmful interference to radio communications. However, there is no guarantee that interference will not occur in a particular installation. If this equipment does cause harmful interference to radio or television reception, which if found by turning the equipment off and on, the user is encouraged to try to correct the interference by one or more of the following measures:

- Reorient or relocate the receiving antenna.
- Increase the separation between the equipment and receiver.
- Connect the equipment to an outlet other than the receiver's outlet.
- Consult a dealer or an experienced radio/TV technician for assistance.

Good ... Typical room - phone, TV  
 Media center - phone, satellite receiver, AV modulators  
 Home office - phone, TV, cable modem  
 Better ... Typical room - phone, TV, ethernet  
 Media center - phone, TV, ethernet, satellite receiver, AV modulators  
 Home office - phone, TV, ethernet, cable modem  
 Best ... Typical room - phone, TV, ethernet, satellite receiver  
 Media center - phone, TV, ethernet, satellite receiver, AV modulators, hi-speed data  
 Home office - phone, TV, ethernet, satellite receiver, cable modem, hi-speed data

	Good	1 Cat-5	1 Cat-5	1 RG-6
Typical Room	Better	2 Cat-5	2 Cat-5	1 RG-6
Media Center	Best	3 Cat-5	3 Cat-5	2 RG-6
Home Office		1 Cat-5	2 Cat-5	3 RG-6

**Wiring a house for OpenHouse®**  
 The cables in an OpenHouse® run from the various rooms of the house directly to the service center location. (This is known as 'home run' wiring.)  
 Two types of wire are used for communication and entertainment: Cat-5, 4-UTP (4 Unshielded Twisted Pairs) wire handles data or 1 to 4 telephone lines. RG-6 coax handles television (antenna or cable), satellite dish, cable modem, or AV modulator signals. (An AV modulator creates new TV channels for front door camera, DVD player, a VCR or a satellite receiver.)  
 We recommend the following pre-wire schemes. Run these wires from the service center to the rooms indicated.



## Linear LLC

2055 Corte Del Nogal, Carlsbad, CA 92009, USA  
 760-438-7000 800-999-5225 fax: 760-931-1340

[www.openhousesystem.com](http://www.openhousesystem.com)

© 2004 Linear LLC, Carlsbad, CA, USA

### Warranty

Linear LLC warrants this OpenHouse product to be free from defects in material and workmanship for 5 years. The time period will be measured using the date code labeled on the product. Linear LLC is not responsible for damage to the product resulting from the buyer's improper handling, stocking or warehousing of the product. Any implied warranty arising from the sale of the product including implied warranties of merchantability and fitness for purpose are limited. Linear LLC shall not be responsible for any losses, damages or expenses, whether direct, consequential, or incidental arising from the use or the inability to use the product. Some states and countries do not allow limitations on how long an implied warranty lasts or the exclusion or limitation on incidental or consequential damages, so the above exclusions may not apply. The Linear LLC warranty gives specific legal rights in addition to other rights, which may exist and vary from state to state and country to country.  
 The warranty is limited to repair or replacement of products returned, freight prepaid, to Linear LLC, there is NO PROVISION FOR LABOR COST OR OTHER REIMBURSEMENTS OF ANY KIND.  
 1. Failures due to product abuse, such as negligence, improper use, and electrical surge including damage from lightning, water damage or other damage due to natural disasters are not covered by the warranty. The most common form of product abuse is surge damage caused by lightning.  
 2. The warranty shall also be voided by any tampering with the date code, labels or other markings on the product.  
 3. Products that are damaged in transit to Linear LLC due to improper packaging or by the carrier (shipping company) will not be covered under the warranty. If the product was damaged or lost by the carrier, it is the sender's responsibility to create a claim against the carrier.  
 4. The user is responsible for all labor costs associated with removing, reinstalling and returning the product to Linear LLC.  
 Linear LLC, at its option, will repair or replace the defective product. Replacements will be made from B-Stock, if an exact replacement is not available, Linear LLC, at its option, will select the nearest equivalent product. The user is responsible for freight charges to Linear LLC. Linear LLC will return warranted repaired or replacements by UPS Ground or an equivalent service. A customer may pay the additional costs for second-day or next-day service.  
 All products returned for warranty service require a Return Product Authorization Number (RPA#). Contact Linear Technical Services at 1-800-999-5225 for an RPA# and other important details.



Compatible

## OpenHouse® Enclosures, Modules, Accessories & Wall Plates

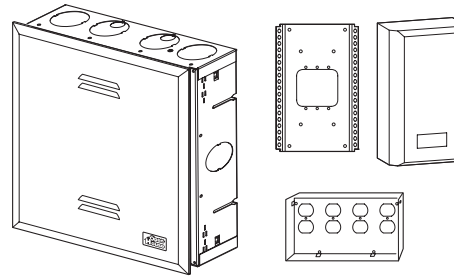

### Service center enclosures

A full line of OpenHouse® compatible enclosures, from simple, inexpensive mounting plates to high capacity in-wall cabinets. AC outlets can be mounted inside the cabinets.

### Starter systems

RF splitters and telephone punch downs. When it is time to upgrade, just snap this module out and replace with one or more of the more sophisticated units.

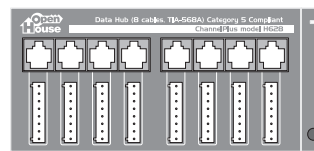
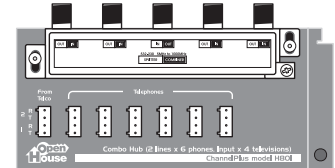

### Data hubs

Termination blocks for the CAT-5e cables, Ethernet switches. Bring the Internet to any room in the home. Or create a home data network.

### Telephone hubs

Connections for 1-4 phone lines to every room. Starter hub adds RJ-31X jack for security system dialer.

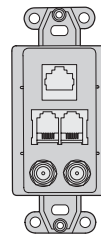
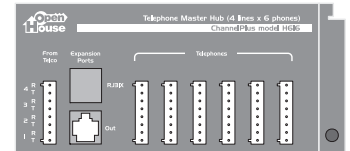

### Wall plates

Wall plate systems for all rooms. The typical room gets TV and telephone. The home office wall plate adds data ports. The media center wall plate adds satellite feeds.

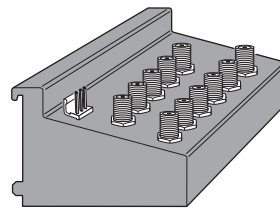

### Coax panels

Distribute antenna or cable TV to every room of the house. Some models include bi-directional amplifiers for interactive cable systems. Some models include modulator inputs and IR engines.

### AV modulators (for service center)

Create a new TV channel for a front door camera. Some models feature Cat-5 input connections.

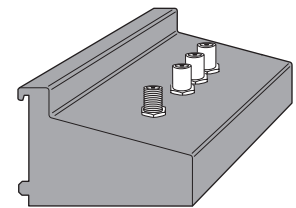

### AV modulators (for media center)

Create new TV channels for DVD, VCR, or a satellite receiver. These modulators sit in the media center. Some offer true MTS stereo.

### IR Accessories

Control video devices from any room.

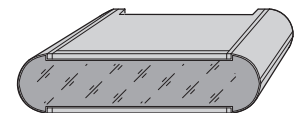

**New OpenHouse® products are added all the time. Visit our website to learn more: [www.openhousesystem.com](http://www.openhousesystem.com)**