



# Modulator Installation Manual



## Frequency-Agile Video Modulator

### Model 5415

This device complies with the FCC's Part 15 Rules for TV interface devices. Any change or modification to this device without the permission of Linear LLC, may void the user's authority to operate this equipment.

**Linear**<sup>®</sup>

(760) 438-7000 USA & Canada (800) 996-5225  
Toll Free FAX (800) 468-1340  
[www.channelplus.com](http://www.channelplus.com)

# Controls and Connections

The ChannelPlus 5400 Series are digitally-tuned video modulators that convert any baseband video and audio signal to a user-selected UHF, or Ultraband CATV. An internal quartz crystal reference oscillator and PLL circuitry ensure drift-free performance. The user selects the output frequency (channel) using the "program" button to enter the number of the desired channel. Any TV connected to the output via coax can receive the signals, when the TV is tuned to the proper channel.

## Model 5415 - Single channel agile modulator



Program button to enter the channel number

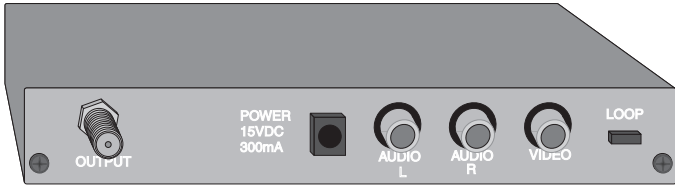

- RF output
- Power supply 15VDC 300mA
- Audio inputs: Right and left are combined for monaural.
- Video input
- Video input termination jumper (When connecting video to a local monitor, remove this jumper for hi-Z)

# Sample System Diagram

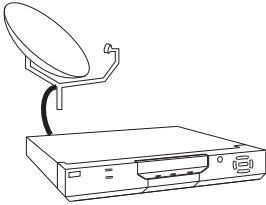

**SATELLITE RECEIVER**

Video/audio out

In this system, CATV or antenna channels are available on all TVs. In addition the following channel has been added:  
**Channel 70 - Satellite receiver**

Option:  
To connect the video and audio to a local monitor, use RCA type 'Y' adaptors and remove the 'LOOP' jumper.

VIDEO  
AUDIO L  
AUDIO R

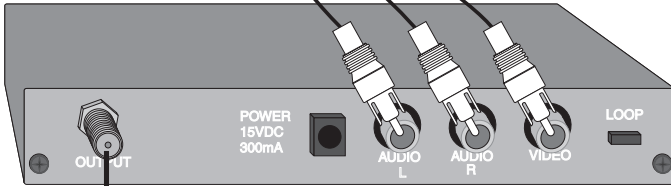

RG6 coax

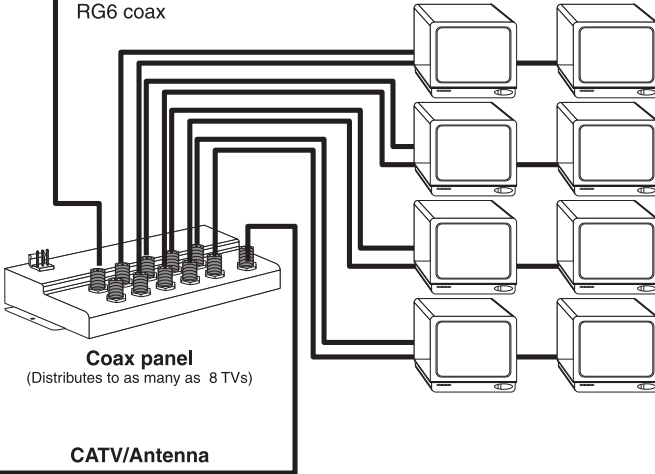

## Programming Examples:

To program modulator to channel 67

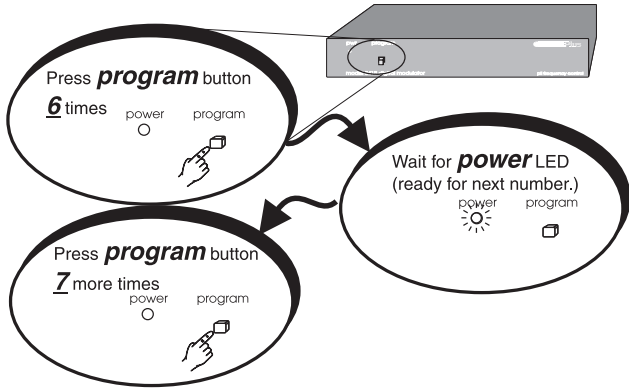

To program modulator to channel 120

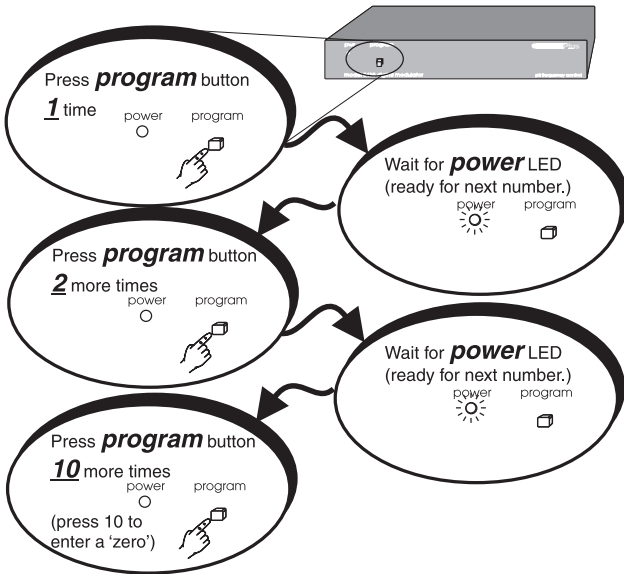

**Valid Channels:** 14-64: UHF channels  
65-125: CATV channels  
95-99: not valid

**Channel Spacing:** Skip at least one number between channels.  
Channels 14 and 16: OK.  
Channels 14 and 15: Illegal.

**Error indication:** If an error has occurred or an incorrect channel is entered, the LED will flash quickly for a second and return to the previous settings.

**Channel number readback:** A readback mode will display the current channel assignments.

## To readback modulator channel assignment

(example: modulator is programmed to channel 108)

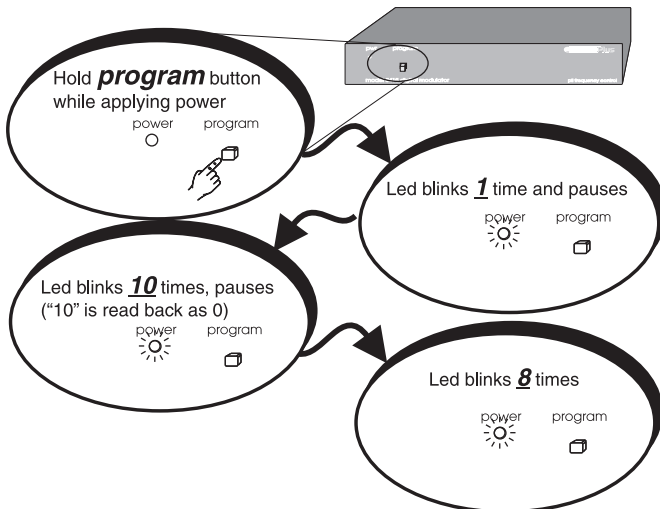

# Things to watch for:

**No picture ...** Verify that the video source is on and is producing a video signal. Check that the TV and the modulator are tuned to the same channel. For example, if the modulator is broadcasting on UHF channel 16, make sure the TV is on UHF 16 rather than CATV 16. UHF 16 and CATV 16 are at different frequencies.

**Weak ChannelPlus UHF channel ...** If the TV has a separate UHF input, be sure that it is connected.

**Herringbone interference on ChannelPlus channel (diagonal lines) ...** You may have chosen a channel number that is not completely vacant. Distant UHF stations may be un-watchable, but will cause interference if you try to try to create a new channel at the same frequency. Also, cable companies often have extra signals where there should be none. Try moving the ChannelPlus channel to another number. You may have to add a low pass filter to remove cable company noise.

**Herringbone interference on many channels (disappears when you remove the modulator) ...** The high output of the ChannelPlus modulator can overdrive many RF amplifiers. Reduce the RF output using an attenuator. (ChannelPlus coax panels are designed to take the full output of these modulators.)

**Audio volume is low ...** The left and right audio inputs are combined for monaural. For proper audio level, both right and left inputs must be used. If you have a mono source, connect it to both right and left inputs using an RCA 'Y' connector.

**No color on ChannelPlus channels ...** You may have chosen the incorrect cable standard. Not all televisions can accommodate the 1.25MHz frequency difference between the H and I cable standards. See the section on programming.

# Changing modulation standards

## Cable HRC and IRC considerations

Most cable services use IRC frequency assignments. This is the default for the ChannelPlus 5400 series modulators. However, if the cable service uses HRC or the TV appears to search for the "house channels," the modulator can be reprogrammed to use HRC assignments by entering the number "98". Set to IRC by entering a "99". Both of these settings are only used for setting HRC/IRC.

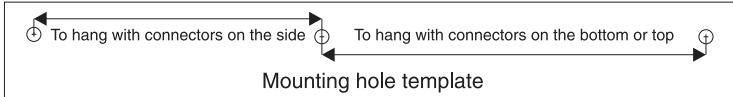

## Specifications: typical @ 25°C ± 5°C

### 5415 Modulator

<b>Inputs</b>	video	1 Vp-p @ 75Ω	
	audio	1 V rms @ 47kΩ	
		L & R inputs combined for monaural	
<b>Video performance</b>	differential gain	4%	
	differential phase	<4°	
	signal/noise	55 dB	
<b>RF output</b>	standard	UHF	CATV
	channel ranges	14-64	65-125 (excluding 95-99)
	output level	+25 dBmV (90dBuV)	
	IM distortion	-60 dBC	
	alternate channel	-45dBC @ 12MHz	
<b>Power supply</b>	model number	350-076	
	output current	300mA	
	output voltage	15 VDC	
	input power	105-125 VAC	
	power consumption	3 watts	
<b>Physical</b>	height	2.5 cm (1.0 in)	
	width	11.7 cm (4.6 in)	
	depth	14.1 cm (5.5 in)	
	weight	0lbs 11 oz (1.19kg)	

## LIMITED WARRANTY STATEMENT

Linear LLC warrants this product to be free from defects in material and workmanship for 2 years. The time period will be measured using the date code labeled on the product. Linear LLC is not responsible for damage to the product resulting from the buyer's improper handling, stocking or warehousing of the product. Any implied warranty arising from the sale of the product including implied warranties of merchantability and fitness for purpose are limited. Linear LLC shall not be responsible for any losses, damages or expenses, whether direct, consequential, or incidental arising from the use or the inability to use the product. Some states and countries do not allow limitations or how long an implied warranty lasts or the exclusion or limitation or incidental or consequential damages, so the above exclusions may not apply. The Linear LLC warranty gives specific legal rights in addition to other rights, which may exist and vary from state to state and country to country.

The warranty is limited to repair or replacement of products returned, freight prepaid, to Linear LLC, there is NO PROVISION FOR LABOR COST OR OTHER REIMBURSEMENTS OF ANY KIND.

1. Failures due to product abuse, such as negligence, improper use, and electrical surge including damage from lightning, water damage or other damage due to natural disasters are not covered by the warranty. The most common form of product abuse is surge damage caused by lightning.
2. The warranty shall also be voided by any tampering with the date code, labels or other markings on the product.
3. Products that are damaged in transit to Linear LLC due to improper packaging or by the carrier (shipping company) will not be covered under the warranty. If the product was damaged or lost by the carrier, it is the sender's responsibility to create a claim against the carrier.
4. The user is responsible for all labor costs associated with removing, reinstalling and returning the product to Linear LLC.

Linear LLC, at its option, will repair or replace the defective product. Replacements will be made from B-Stock, if an exact replacement is not available, Linear LLC, at its option, will select the nearest equivalent product. The user is responsible for freight charges to Linear LLC. Linear LLC will return warranted repaired or replacements by UPS Ground or an equivalent service. A customer may pay the additional costs for second-day or next-day service.

All products returned for warranty service require a Return Product Authorization Number (RPA#). Contact Linear Technical Services at 1-800-421-1587 for an RPA# and other important details.