

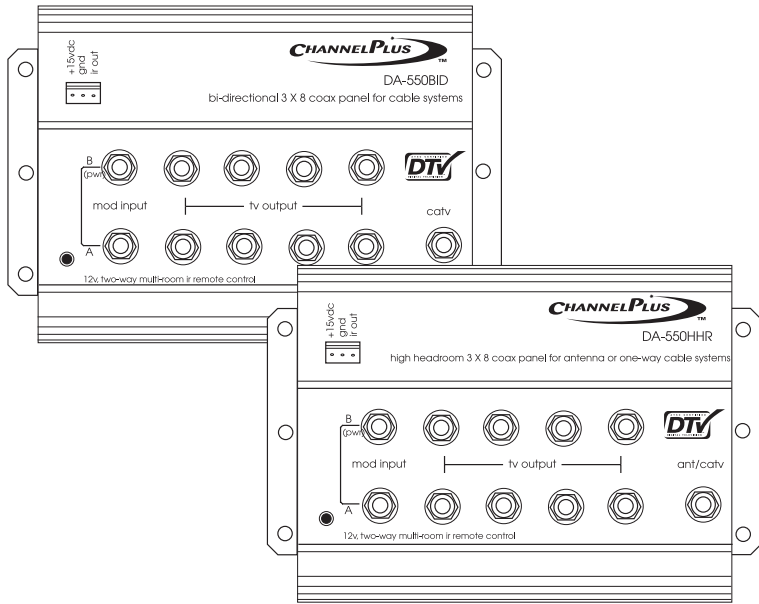

PERFORMANCE MULTI-ROOM VIDEO

3 x 8 Coax Cable Panel DA-550BID DA-550HHR



Linear
Building On Innovation.

USA & Canada (800) 421-1587 & (800) 392-0123
(760) 438-7000 - Toll Free FAX (800) 468-1340
www.linearcorp.com

MANUAL-DA-550HHR/BID - LINEAR P/N: 600-195 H - INK-BLACK - MATERIAL: 20# MEAD BOND - SIZE: 5.500" X 8.500" - FOLDING: ALBUM FOLD - BINDING: SADDLE STITCH - SCALE: 1-1
PRINTERS INSTRUCTIONS:

Model DA-550

The DA-550 is the heart of a multi-room distribution system. The DA-550 connects as many as 8 televisions to cable or antenna, while maintaining compatibility with ChannelPlus video modulators and the bi-directional, 12V, IR repeating system.

Contents: DA-550
 Additional mounting ears*
 Power Supply (15VDC @ 300mA)
 Power/IR adaptor

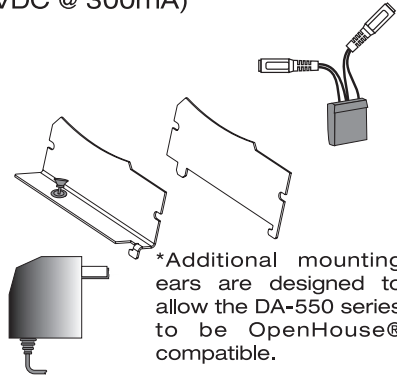
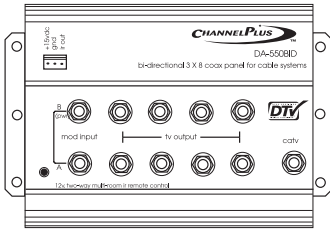

*Additional mounting ears are designed to allow the DA-550 series to be OpenHouse® compatible.

Model Differences:

The **DA-550HHR** is for antenna or uni-directional cable systems. The HHR has the highest headroom of any coax panel available in the market.
 The **DA-550BID** is for bi-directional cable systems providing a 5-42MHz back channel for cable modems or interactive set-top boxes.

Accessories:

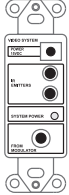

Model 2010
 Power injector wall plate
 Powers the DA-550 remotely and has a built-in IR wall plate.



Series 5500 and series SVM modulators create local TV channels, have built-in IR engines, and can remotely power the DA-550.

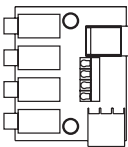

Model 2184 IR breakout replaces the power supply adaptor and drives up to four IR emitters.



Model 2181 IR extender allows IR signals to be passed from one DA-550 to another.

Typical Installation:

The DA-550 works like a zero-loss splitter. The signals you put on the antenna/CATV input will appear on the outputs with about 3dB of gain.

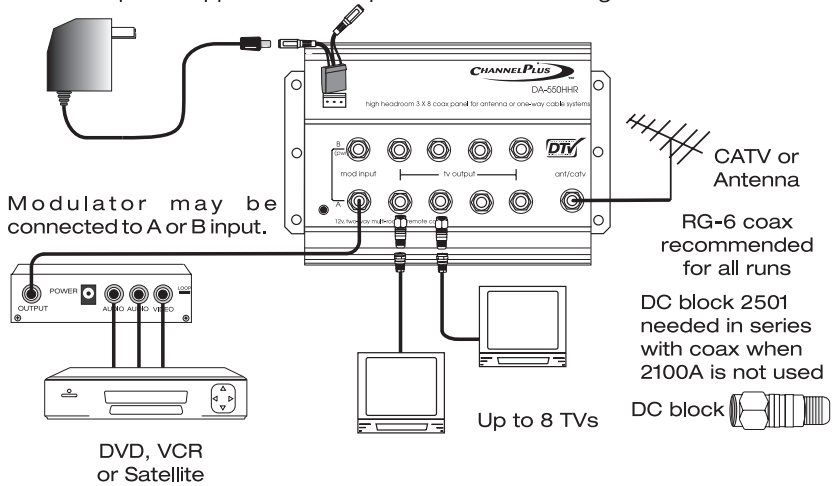

Remote Powering the DA-550

Put the DA-550 coax panel where the coax is: often the basement or garage. The single coax carries power, RF signals and IR repeating signals. You can remote power the DA-550 from series 5500 or series SVM modulators, or from a model 2010 wall plate.

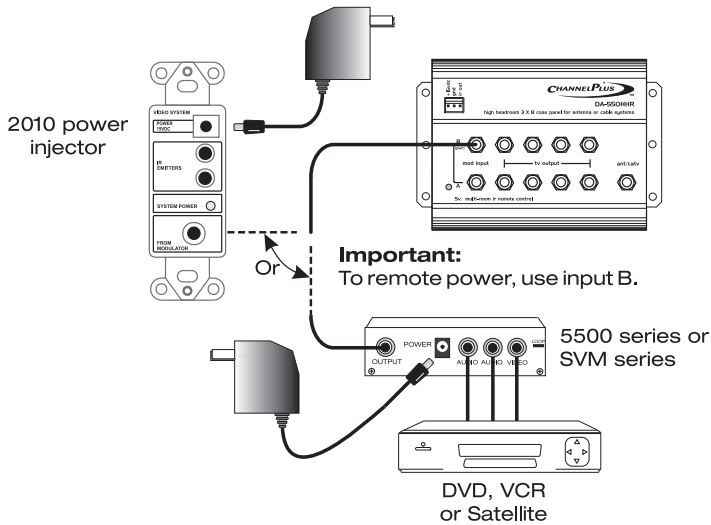

IR Repeating System:

With DA-550 you can also control your video devices from any room in the house. Any or all 8 outputs may be connected to the model 2100A wall plates. The 2100A will interface with models 2130A, 2231 & 2132 IR targets as well as a variety of industry standard IR receivers. Direct your remote control at the IR target and the 2173 IR emitter will repeat the IR signal to the video devices in the media room.

Normally, the IR emitters are also connected to the model 2100A wall plates. But, if the coax panel is located in the media center, you may chose to connect the emitters to a model 2184 IR breakout panel. Both examples are shown below.

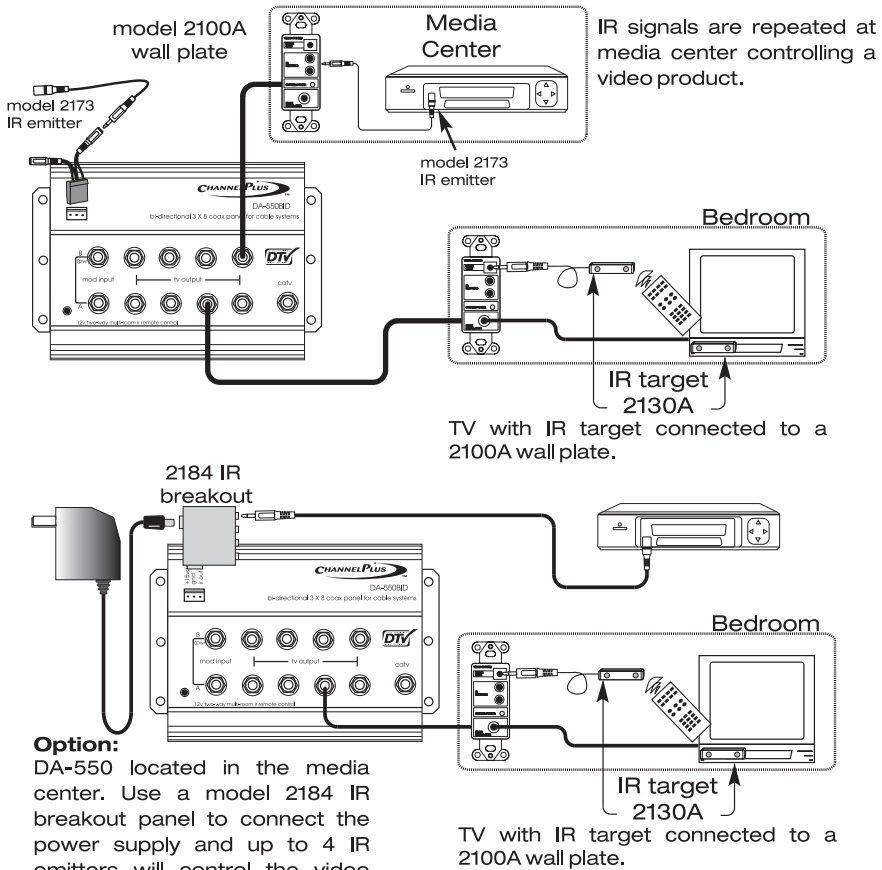

IR Systems: 12V vs. 5V

- There are two common IR repeating systems. The 12V system is very versatile and intended for professional installation. The 12V system is compatible with Xantech IR receivers
- The DA-550 coax panels use the 12V system.
- 12V and 5 V IR targets are NOT interchangeable. The emitters ARE interchangeable. The 2010 wall plate, 550 series modulations and SVM series modulators ARE compatible with both 12V and 5V systems.

12V IR Systems: Troubleshooting

1) If IR light glows steadily, there is noise

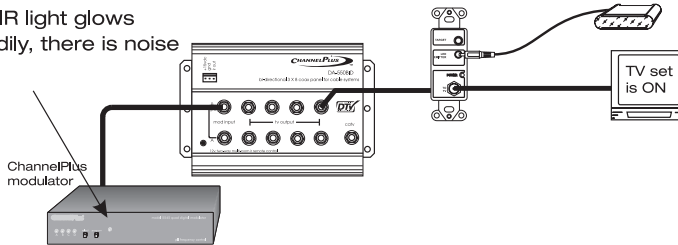

2) First disconnect the coax cables from all of the television output jacks. Find the source of the noise by re-connecting cables one at a time until the IR light glows. This identifies that coax as a noise source. Connect this noisy coax only for the next steps. Remember that there could be more than one source of noise, so you may need to repeat the following steps for each coax. Now step 3 will determine which type of noise problem you have.

3a) Optical noise. Cover the target with a towel. If the IR lights stops blinking, you have optical noise. The target may be pointed at a window, a fluorescent light or a plasma TV. Reposition the target so it can't "see" the source of IR light. If the IR light still glows, proceed to the next step.



3b) EMI noise: TV sets are sources of EMI, electromagnetic interference. Move the target away from the TV and try to reposition the target so the IR light stays off.



If the system trips the circuit breakers (IR systems only)

Using DC blocks. All output ports must be connected to a 2100A wall plate OR a DC block. If DC blocks are not used, the internal circuit breakers may trip to protect the system. (An output port that is not used will not trip the system and requires no DC block.)

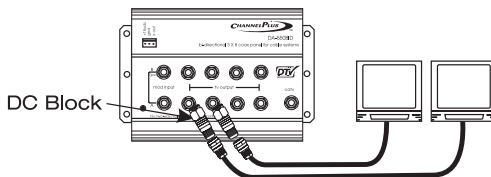

Use a DC block on all output ports that do not connect to a 2100A wall plate. (IR systems only)

Expanding the DA-550:

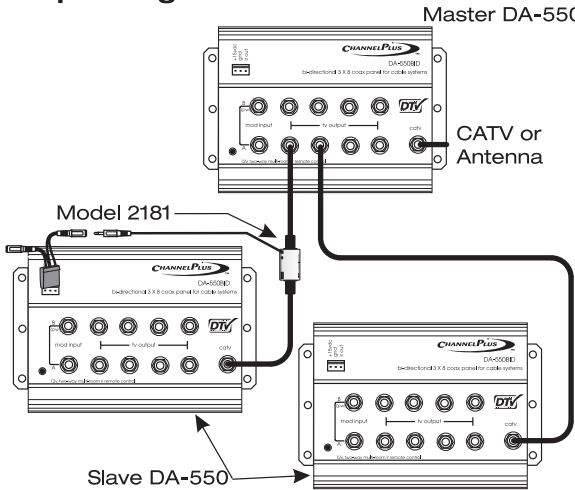

Up to 64 TV outlets

You may connect up to 8 more DA-550s to the outputs of a *master* DA-550, for a total of 64 TV outlets. The longest recommended coax run should not exceed 150'. That is a total of the coax from *master* to *slave* and *slave* to TV.

Each DA-550 must be powered individually. Each *slave* DA-550 can have local modulators and a zoned IR system for TVs connected to the eight outputs. Any modulator signals injected into a *slave* DA-550 will be viewable only on the eight TVs connected to it. Modulators connected to the *master* DA-550 will be viewable on all TV outputs including *slave* DA-550s. To combine IR control signals of *slave* DA-550 units, use one 2181 IR extender for each *slave* DA-550. (See model 2181 instruction manual)

Circuit Breaker:

The model 2010 and DA-550 have built-in circuit breakers. If any of power LEDs are not lit, reset the circuit breaker by disconnecting and reconnecting the power supply. If the system does not reset, look for an installation error.

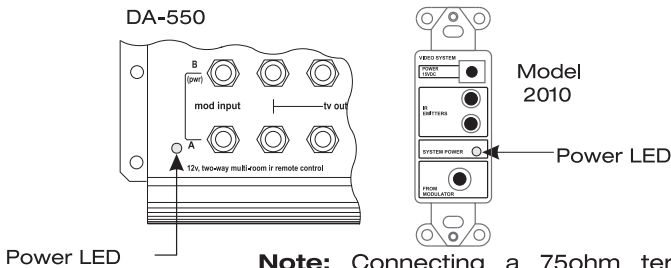

Note: Connecting a 75ohm terminator directly to an output of a DA-550 will cause the circuit breaker to trip.



FCC Requirements:

THIS PRODUCTS COMPLIES WITH FCC REQUIREMENTS. A SYSTEM USING THIS DEVICE WILL COMPLY WITH FCC REQUIREMENTS. USE ONLY VIDEO MODULATORS THAT COMPLY WITH PART 15 OF THE FCC RULES AND HAVE A 25dBmV MAX OUTPUT LEVEL. FAILURE TO DO SO MAY VOID THE USER'S AUTHORITY TO OPERATE THIS EQUIPMENT.

THE DA-550HHR IS SUITABLE FOR USE WITH AN ANTENNA OR WITH CATV SYSTEMS.

THE DA-550BID IS SUITABLE FOR USE WITH CATV SYSTEMS.

Things To Watch For:

Herringbone interference on modulator channel (diagonal lines): You may have chosen a channel number that is not completely vacant. Distant UHF stations may not be watchable, but will cause interference if you try to create a new channel at the same frequency. Also, cable companies often have extra signals where there should be none. Try moving the modulator channel to another number. You may have to add a low pass filter to remove the cable company noise. If the filter does not work, try adding a DC-block to remove common mode interference.

Herringbone interference on many channels, including modulator channels (disappears when you remove the CATV/antenna feed): The RF amplifier can be overloaded by abnormally strong signals. Often, you can cure the problem with a simple attenuator. Use a variable attenuator and try to find a signal level where the interference just disappears. Sometimes, the problem is one station is far stronger than the rest. In this case, attenuating all of the signals with a simple attenuator will cause the desired stations to be weak (snowy). You must reduce the strength of the only offending station. A common FM trap will help if the problem is a nearby FM tower. If the problem is a nearby TV station, often the station management can provide suitable filters.

We recommend using only RG-6 coax when wiring a house. Why? Although good RG-59 has only slightly more loss than RG-6, it is harder to find a good RG-59 with wide bandwidth. RG-6 is a little more expensive and a little harder to run (it is thicker). But you will avoid surprises if you stick to RG-6.

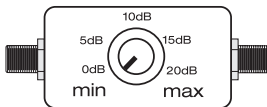

Inexpensive variable attenuator

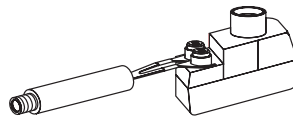

Inexpensive DC block for RF

Specifications: typical @ 25°C ± 5°C

Gain:	DA-550HHR	DA-550BID
CATV/Antenna port to output	3dB	3dB
Modulator input to output	-10dB	-10dB
Output to CATV (reverse) (5-42MHz)	n/a	-15dB
Isolation	>80dB	>35dB
Modulator input to CATV/Ant	5-1000MHz	54-1000MHz fwd 5-42MHz reverse
Max CATV/Antenna input	20dBmV(+80dBuV)	20dBmV(+80dBuV)
Power Supply (included)	15 VDC @ 300mA	15 VDC @ 300mA
General		
Width x height x depth (cm)	6.5" x 1.25" x 4.5"	
Shipping weight	3 lbs.	

LIMITED WARRANTY STATEMENT

Linear LLC warrants this product to be free from defects in material and workmanship for 2 years. The time period will be measured using the date code labeled on the product. Linear LLC is not responsible for damage to the product resulting from the buyer's improper handling, stocking or warehousing of the product. Any implied warranty arising from the sale of the product including implied warranties of merchantability and fitness for purpose are limited. Linear LLC shall not be responsible for any losses, damages or expenses, whether direct, consequential, or incidental arising from the use or the inability to use the product. Some states and countries do not allow limitations or how long an implied warranty lasts or the exclusion or limitation or incidental or consequential damages, so the above exclusions may not apply. The Linear LLC warranty gives specific legal rights in addition to other rights, which may exist and vary from state to state and country to country.

The warranty is limited to repair or replacement of products returned, freight prepaid, to Linear LLC, there is NO PROVISION FOR LABOR COST OR OTHER REIMBURSEMENTS OF ANY KIND.

1. Failures due to product abuse, such as negligence, improper use, and electrical surge including damage from lightning, water damage or other damage due to natural disasters are not covered by the warranty. The most common form of product abuse is surge damage caused by lightning.
2. The warranty shall also be voided by any tampering with the date code, labels or other markings on the product.
3. Products that are damaged in transit to Linear LLC due to improper packaging or by the carrier (shipping company) will not be covered under the warranty. If the product was damaged or lost by the carrier, it is the sender's responsibility to create a claim against the carrier.
4. The user is responsible for all labor costs associated with removing, reinstalling and returning the product to Linear LLC.

Linear LLC, at its option, will repair or replace the defective product. Replacements will be made from B-Stock, if an exact replacement is not available, Linear LLC, at its option, will select the nearest equivalent product. The user is responsible for freight charges to Linear LLC. Linear LLC will return warranted repaired or replacements by UPS Ground or an equivalent service. A customer may pay the additional costs for second-day or next-day service.

All products returned for warranty service require a Return Product Authorization Number (RPA#). Contact Linear Technical Services at 1-800-421-1587 for an RPA# and other important details.