

CONGRATULATIONS!

Your purchase of an M&S music and communications system is an investment that will provide years of enjoyment and service for your customer.

M&S audio products are backed with more than 40 years of experience in the design and manufacture of precision acoustical equipment for the home. To ensure that your customer receives the high-quality music and voice reproduction that the system is designed to deliver, it is important that each step of the installation be done carefully. If you follow the step-by-step illustrated instructions below, the result will be a successful professional-quality installation. In the event you need troubleshooting assistance, please call our technical staff at 1-800-366-9422.

INSTALLATION INSTRUCTIONS FINISH-OUT MC602 SYSTEM

Tools required: Phillips screwdriver #2, Standard flat screwdriver #1, wire stripper/cutter.

The finish-out installation should be made after the application of wall covering material.

DOs & DON'Ts

- **USE ONLY M&S SYSTEMS BRAND CABLE** as called out in these instructions. The cable is designed and constructed with electrical specifications necessary for proper audio performance. **IMPORTANT: THE USE OF NON M&S SYSTEMS' BRAND CABLE OR CABLE SUBSTITUTION WILL VOID PRODUCT WARRANTY.** Note: All M&S Systems' cable has M&S Systems and the part number printed on it!
- **DO NOT** power up master until all remote stations and speakers are connected.
- **DO** ensure that all rough-in instructions (*literature number 115750*) have been followed before power is applied to system.
- **DO NOT SPLICE CABLES.** Splices are unreliable and defeat the signal isolation properties of the cable.
- **DO NOT COIL OR BUNDLE** the MS4X cable. This will cause electronic feedback.
- If extra cables have been run for possible future speaker additions, care must be taken that these cables do not get connected to the master unit. Unterminated cables (no station) connected to the master unit may cause electronic feedback that will damage the master unit.
- **DO NOT** overtighten the screws for the remote stations or the master as the plastic face panels may crack or strip out.

REMOTE STATIONS N65 SERIES

At each remote station location, strip approximately 4 Inches of jacket (MS4XSC) from wire and separate the colored conductors from one another. Strip 1/2 Inch of insulation from each conductor as shown in figure 1. Cut each shield drain

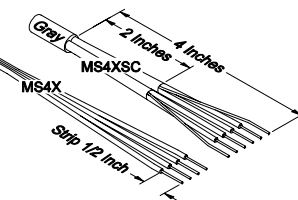

Figure 1

foil to prevent them from touching each other (MS4XSC only). Connect each colored conductor to its respective screw terminal as shown in figure 2. Mount each remote station to its mounting ring using the two screws provided with each station as shown in figure 3.

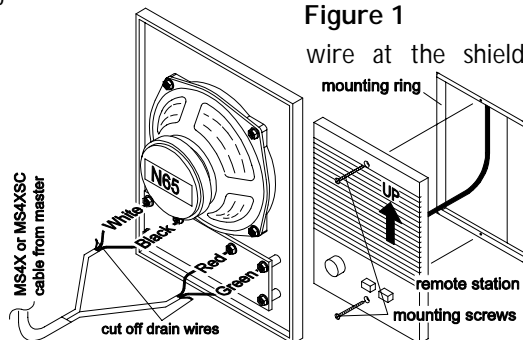

Figure 2

Figure 3

SATELLITE CONTROL STATIONS NRC65 SERIES

At each satellite control station location, strip approximately 4 Inches of jacket (MS4XSC and MS2SXSC) from wires and separate colored conductors from one another. Strip 1/2 Inch of insulation from each conductor. Cut off the drain wire from the Black/White pair. Connect the remaining drain wires together from both cables

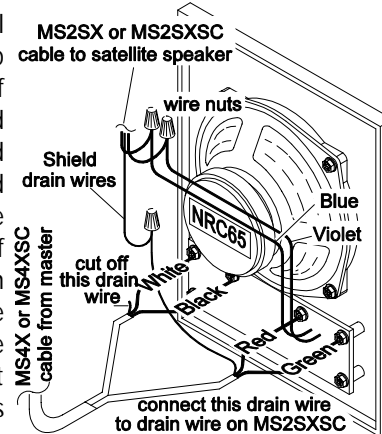

Figure 4

using a wire nut (MS4XSC only). Terminate each colored conductor to its respective screw terminal as shown in figure 4. Connect the Blue and Violet wires to the terminals on the satellite speaker(s). Mount the satellite control station to mounting ring or housing using the two screws provided with the station.

SATELLITE VOLUME CONTROL MVC1 SERIES

At each satellite control station location, strip approximately 4 Inches of jacket (MS4XSC and MS2SXSC) from wires and separate colored conductors from one another. Strip 1/2 Inch of insulation from each conductor. Connect drain wires together from both cables using a wire nut (MS4XSC only). Wire nut each colored conductor to its respective wire as shown in figure 5. Connect Blue and Violet wires to the corresponding terminals of the satellite speaker(s). Mount the volume control to the single gang box using the two screws provided with the volume control.

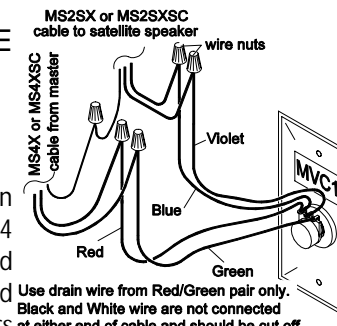

Figure 5

PATIO REMOTE STATIONS NW65 SERIES

At each remote station location, strip approximately 4 Inches of jacket (MS4XSC) from wire and separate colored conductors from one another. Strip 1/2 Inch of insulation from each conductor. Cut each shield drain wire at the shield foil to prevent them from touching each other (MS4XSC only). Connect each colored conductor together using wire nuts as shown in figure 6. Mount the patio station to housing using the two screws provided with the station.

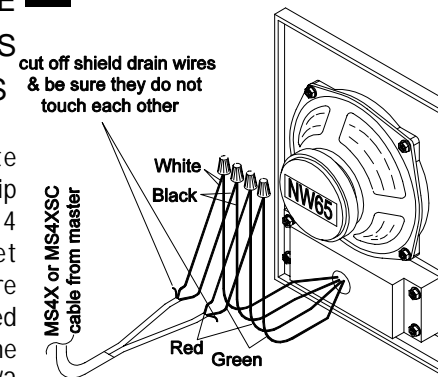

Figure 6

SATELLITE CONTROL STATIONS N W R C 6 5 SERIES

At each satellite control station location, strip approximately 4 Inches of jacket (MS4XSC and MS2SXSC) from wires

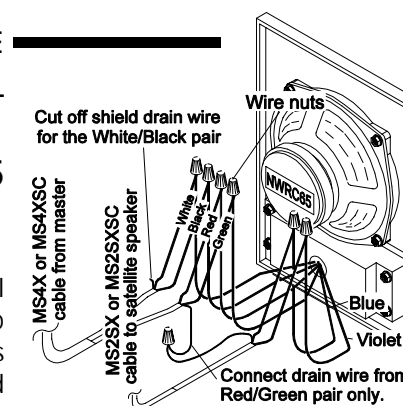

Figure 7

and separate colored conductors from one another. Strip 1/2 Inch of insulation from each conductor. Connect drain wires together from both cables using a wire nut (MS4XSC only). Connect each colored conductor together using wire nuts as shown in figure 7. Terminate Blue and Violet wires to the corresponding terminals of the satellite speaker(s). Mount satellite control station to mounting ring or housing using the two screws provided with the station.

EXTERNAL MUSIC SOURCE AWPM

Connect the cables from the gang box to the 'Y' cables shipped with the AWPM wall plate as shown in figure 8. Use the labels provided to mark the plate as identified on the respective cables. Connect the 'Y' cables to the plate as shown and mount the plate using the two screws provided.

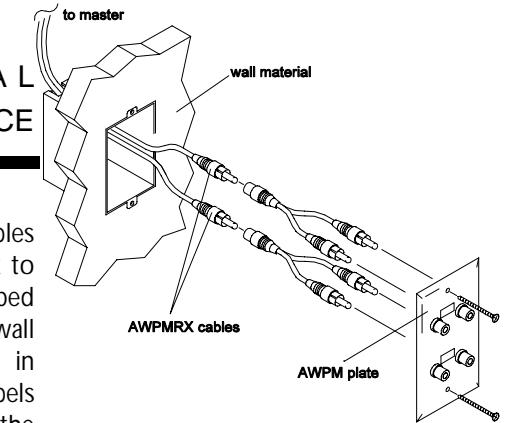

Figure 8

DOOR STATIONS SERIES DS3/DS3B & BD3/D3/BD3B/D3B

At each door station location, strip approximately 4 Inches of jacket from wire and separate colored conductors from one another. Strip 1/2 Inch of insulation from each conductor as shown in figure 9. Cut each shield drain wire at jacket to prevent them from touching each other (MS4DCXSC only). Terminate yellow and orange wires to the screw terminals on the bell button (if equipped). Connect the Red and Black wires to the Red and Black wires on the speaker respectively. Refer to figure 10. Mount door station to housing using the two screws provided with station.

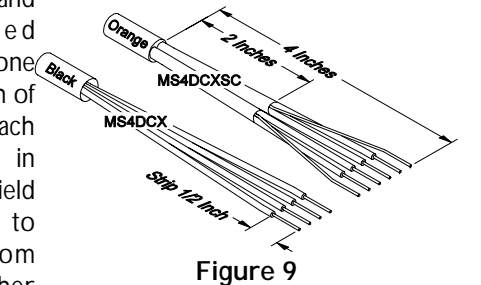

Figure 9

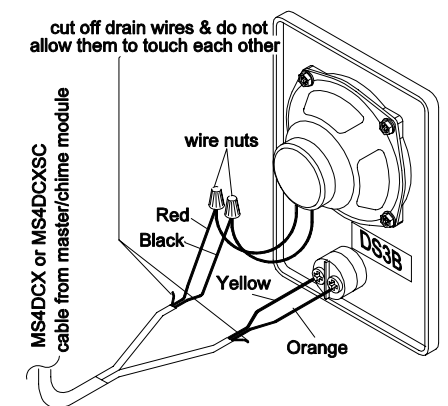

Figure 10

MC602 series master station hookup

Gather all remote and door station cables and cut cable ends to the same length approximately 12 inches from entry point in wall housing. Strip off approximately 8 inches of jacket and shield foil from each cable (MS4XSC/MS4DCXSC). Strip 1/2 inches of insulation from each individual conductor. See figure 11.

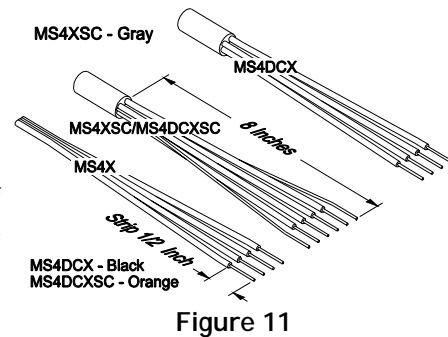

Figure 11

Install the optional chime module MC3 or MC8 in the upper left corner of the wallhousing by pressing the chime module over the 4 plastic standoffs attached to the wall housing as shown in figure 12. Refer to the instructions shipped with the chime module.

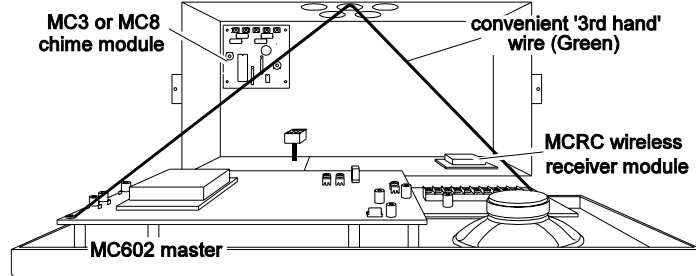

Figure 12

Suspend the master unit from wall housing by looping the third hand wire (thick green wire) over the hook at the top of the housing. Be careful not to damage wall surface. See figure 12.

Pigtail all shield drain wires (bare) to the shield terminal on the master. Insulate the bare wires using some of the jacket material to prevent shorting to the circuit board. Group all Red, Black (except patio Black) and White wires from the remote stations

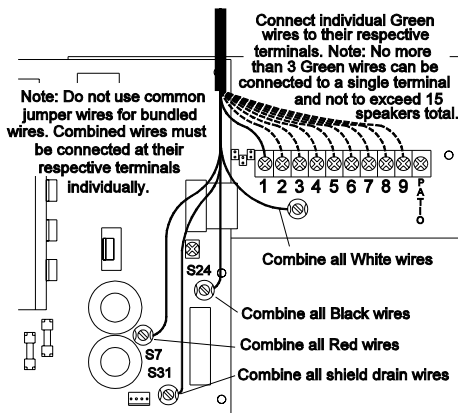

Figure 13

(MS4X/MS4XSC cables) and connect to the Red, Black and White terminals respectively on the master unit as shown in figure 13. **Do not connect the door stations at this time (MS4DCX/MS4DCXSC).** Connect each Green wire (except patio Green) to a single green terminal on the master. Each numbered Green terminal corresponds to a remote station selector switch. (Note: No more than 3 Green wires can be connected to any Green terminal and not to exceed 15 speakers for the system. This limitation does not include remote controls, volume controls or door

stations.) The station location can be marked on the inside of the lower access door panel.

Connect the green wire(s) from the patio station(s) to the Patio green terminal. Connect the patio Black wire(s) to the patio Black terminal. (Note: Only two patio stations can be connected to the patio terminals.) Connect the Red wire with the other Red wires, Connect the White wire with the other White wires.

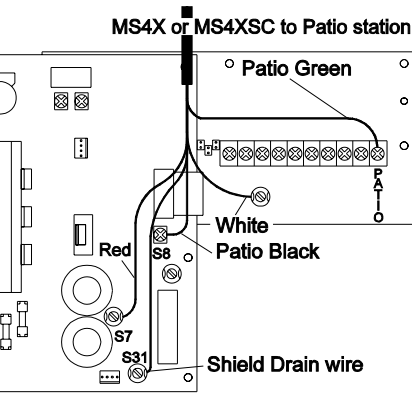

Figure 14

Connect the Red and Black wires of the door station cable(s) (MS4DCX/MS4DCXSC) to the Red and Black door speaker terminals of the master as shown in figure 15. Insulate the bare wires using some of the jacket material to prevent shorting to the circuit board. Connect all Orange wires from the Door stations to the Common terminal on the MC3 or MC8. Connect each Yellow wire to each note selection terminal. (Do not connect more than one Yellow wire per note terminal.)

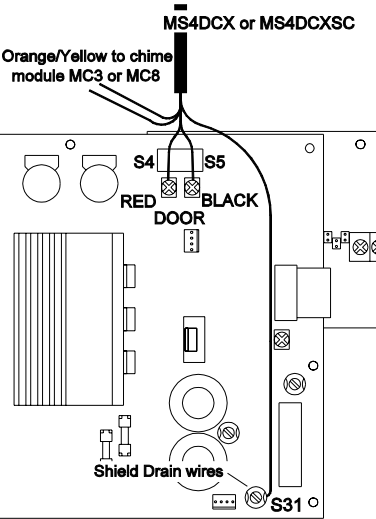

Figure 15

Connect the FM dipole twin lead antenna to the FM 300 Ohm terminals of the master as shown in figure 16. Connect orange AM antenna wire to the AM terminal.

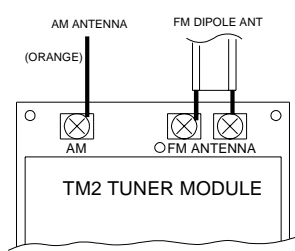

Figure 16

Plug in the optional modular chime plug to the 4 pin connector labeled as CHIME on the master unit. See figure 17.

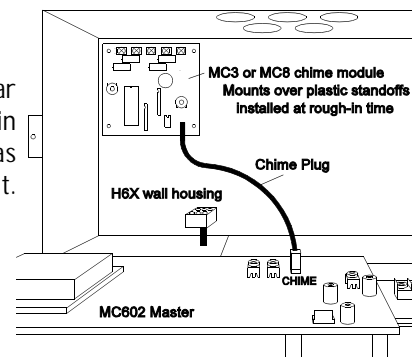

Figure 17

To install the optional wireless remote control receiver module MCRC, attach the MCRC module using the velcro strips provided to the lower right bottom of the wall housing as shown in figure 18. For applications using the HC6X wall housing, install the receiver module in the lower center back of the wall housing as shown in figure 19. Place the white antenna lead through the hole provided in the wall housing into the wall cavity. Failure to do so may result in poor range of the wireless remote control system. Connect the wire harness from the MCRC to the connector labeled REMOTE on the master as shown in figure 18.

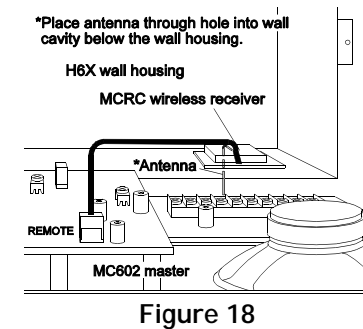

Figure 18

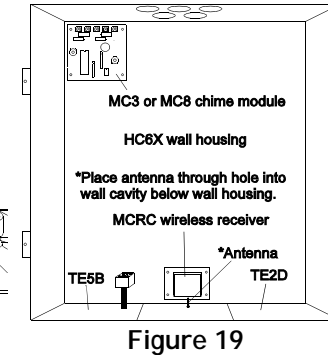

Figure 19

The MC602 uses an optional relay for the door release feature. To implement the door release operation, install the RL602 relay module. This relay is installed into the socket on the master labeled K1. See figure 20. For implementation of the DRW door release, connect the VM127X cables from the remote power transformer and the DRW door release striker as shown in figure 20. The 24Volt/1Amp dry contact switch closure may also be used for home automation or security panel panic alarm interface. **Note: The door release operation may only be used for one type of function per application.**

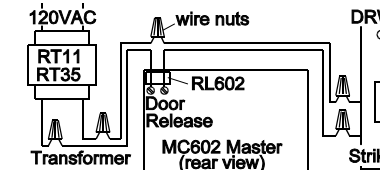

Figure 20

MONITOR OVERRIDE FEATURE

The MC602 is shipped from the factory without the monitor override feature set. The monitor override feature allows chime and room talk functions to override any station that is in the monitor position. If monitor override is desired, remove the jumper from P1 and connect across P3. Place the spare jumper from P2 across P2 as shown in figure 22. (A pair of needlenose pliers may be necessary to move the jumpers).

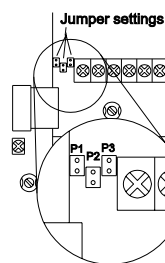

Figure 21

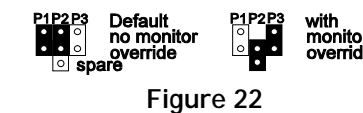

Figure 22

After all connections have been made, insert the power plug into the TE5B transformer. Check that the three LED's light up with equal intensity and secure the master to the wall housing using the 2 screws provided. If using a wood trim ring, install the master unit over the wood trim. Do not overtighten the screws as the plastic may distort or crack.

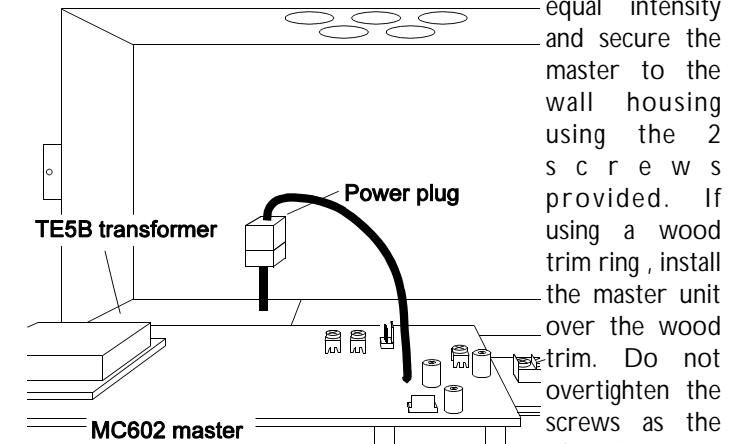

Figure 23

Install the face panel insert over the master as shown in figure 24. All buttons must protrude through the insert in order to secure it. Check all functions by following the guidelines in the operating guide shipped with the master unit. If any difficulties are encountered, recheck all connections. If after reviewing these instructions you are unable to resolve any problems, contact technical support at 1-800-366-9422.

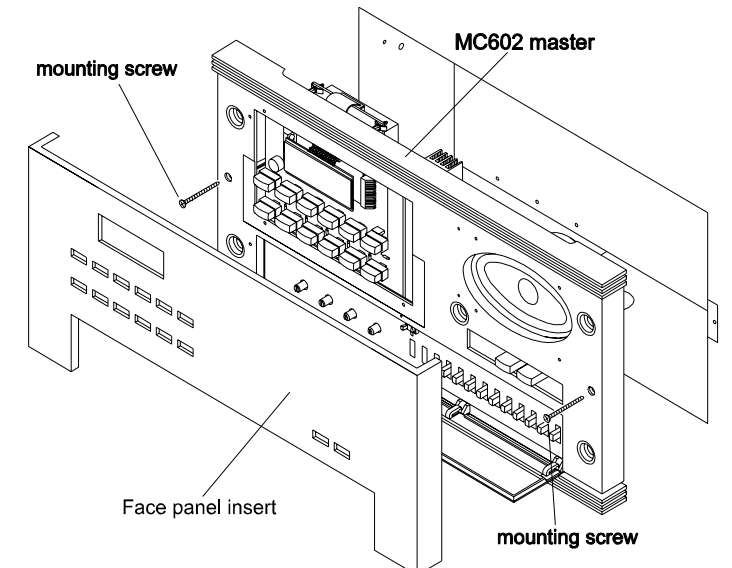

Figure 24

M&S SYSTEMS
115755 Rev D

7 2 7 0 6 6 0 7 8 3 8 4

M&S SYSTEMS 2-YEAR "NO FAULT" LIMITED WARRANTY
M&S Systems warrants for two years (2) from the date of "first user" purchase all MC602 products to be free of factory-caused defects in material and workmanship. M&S Systems will repair or replace, at its option, parts and materials at no charge, regardless of the problem. This warranty extends to the original purchaser of the product and to each subsequent owner of the product during the term of this warranty. This NO FAULT warranty covers only the liability described above, and does not include liability for incidental or consequential damages. NOTE: Some states do not allow the exclusion or limitation of incidental or consequential damages, so the above limitation or exclusion may not apply to you.